



**austriamicrosystems AG**

**is now**

**ams AG**

The technical content of this austriamicrosystems document is still valid.

**Contact information:**

**Headquarters:**

ams AG  
Tobelbaderstrasse 30  
8141 Unterpremstaetten, Austria  
Tel: +43 (0) 3136 500 0  
e-Mail: [ams\\_sales@ams.com](mailto:ams_sales@ams.com)

Please visit our website at [www.ams.com](http://www.ams.com)

# AS5000 Programmer

## OPERATION MANUAL

### Programming Tool

## 1 General Overview

This operational manual describes the function of the *AS5000 Programmer* in combination with the programming boards. This tool can program the austriamicrosystems AS5000 series magnetic rotary encoders. The graphical user interface (GUI) runs on PC running Windows XP or later and controls the programmer via the USB interface. All major access modes to the OTP memories can be established. Be aware that austriamicrosystems provides the *AS5000 Programmer* as a reference for programming and reading of mentioned devices (refer to Appendix A) under laboratory conditions (no warranty for mass production).

**Note:** Since firmware version v2.10 the AS5000-Programmer contains a boot loader, which provides an update function for new software release. Please refer to the corresponding **application note AN5000-60** (available on our webpage).

## 2 Hardware Components

### 2.1 Description of the Hardware Components



Figure 1: Three components of the Programmer solution

Figure 1 shows the three components which are needed to program the austriamicrosystems magnetic rotary encoder. Take care that the connector between programming box and programming board is plugged in the right way.

**Warning:**  
In case of wrong connection, the components in the AS5000 programmer or the encoder can be destroyed!

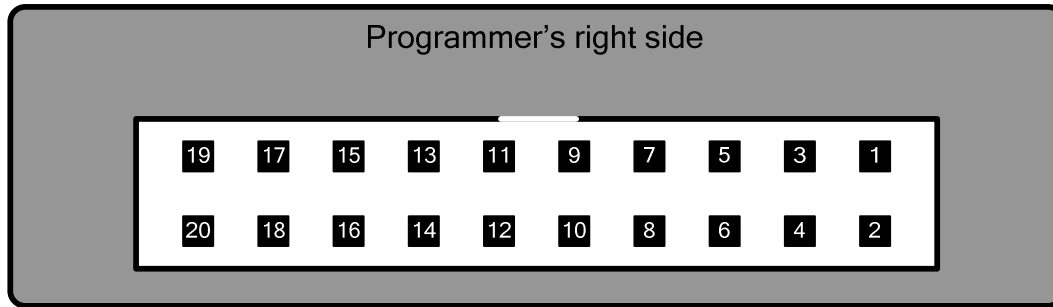

Figure 2: AS5000 Programmer MRE connector (right side view)

Pin #	Signal	Comment
1	Vzap	Programming voltage
2	Vzap	Programming voltage
3	D10	Encoder signal
4	ADC2	Device autodetection voltage
5	D9	Encoder signal
6	ADC1	Vzap feedback
7	D8	Encoder signal
8	D11	Encoder signal
9	D7	Encoder signal
10	D6	Encoder signal
11	VDD	Encoder power supply
12	VDD	Encoder power supply
13	GND	Ground
14	GND	Ground
15	D5	Encoder signal
16	D0	Encoder & LCD display signal
17	D4	Encoder signal
18	D1	LCD signal – Do not use
19	D3	Encoder & LCD display signal
20	D2	Encoder & LCD display signal

## 2.2 Description of the programming board

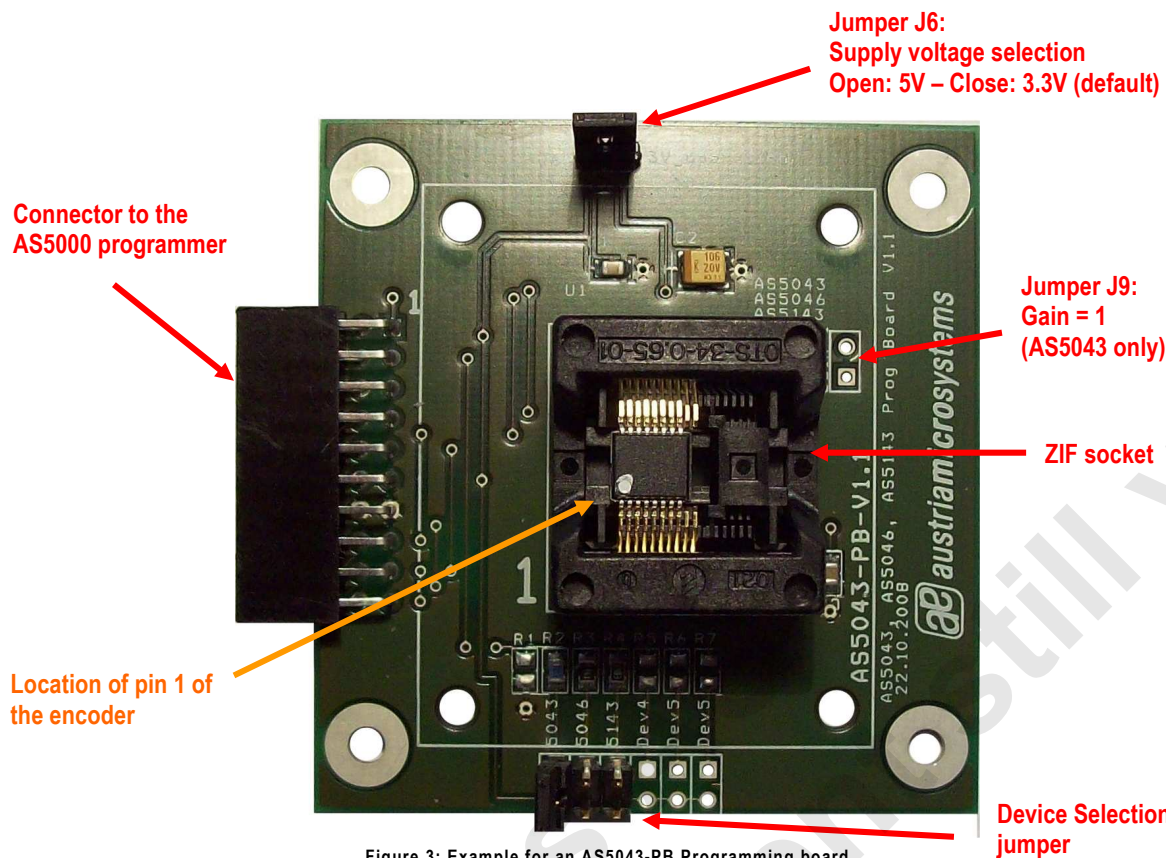

Figure 3: Example for an AS5043-PB Programming board

The programming board (AS5xxx-PB) is specific for a group of devices. By jumper setting on this board the build in firmware in the programming box automatically detects the selected device. It is not recommended to change the jumper setting to a different encoder type than installed in the socket.

To place or remove a device from the socket, push the black frame of the socket down. This socket has more connectors as the AS50xx/ AS51xx part and therefore it is important to align the device to the left side of the socket. The pin 1 of the device must be on the bottom left side. Figure 2 shows the detailed placed device in the socket.

The jumper J9 is specific for the AS5043/AS5143. This Jumper is used to close the feedback loop used for the analog output operation mode. With this jumper the gain can be set to 1.

The jumper J6 is by default closed because the AS5000 Programmer provides 3.3V operation. In case of 5 V operation the jumper must be removed and the configuration can be changed over the GUI.

## 3 Installation

### 3.1 Hardware setup

First connect the AS5xxx-PB to the 20-pin connector of the AS5000 Programmer, as shown on Figure 1. The AS5000 Programmer is directly powered by the PC via USB. An external power supply is not needed.

### 3.2 Installing the GUI on the PC

The preliminary software is developed for a Microsoft Windows XP operating system with Service Pack 2. In addition the dotnet (.NET) framework version 2.0 or more must be installed on the PC. This package can be downloaded free of charge from the Microsoft webpage:

<http://www.microsoft.com/downloads/details.aspx?FamilyID=0856eacb-4362-4b0d-8edd-aab15c5e04f5&displaylang=en>

Following Procedure is recommended before starting the GUI:

1. check on your PC if Service Pack 2 is installed
2. install the mentioned .net package to your computer
3. execute AS5000GUI\_setup.exe
4. Finally start the GUI using the shortcut in the start menu or desktop.

## 4 Graphical User Interface (GUI)

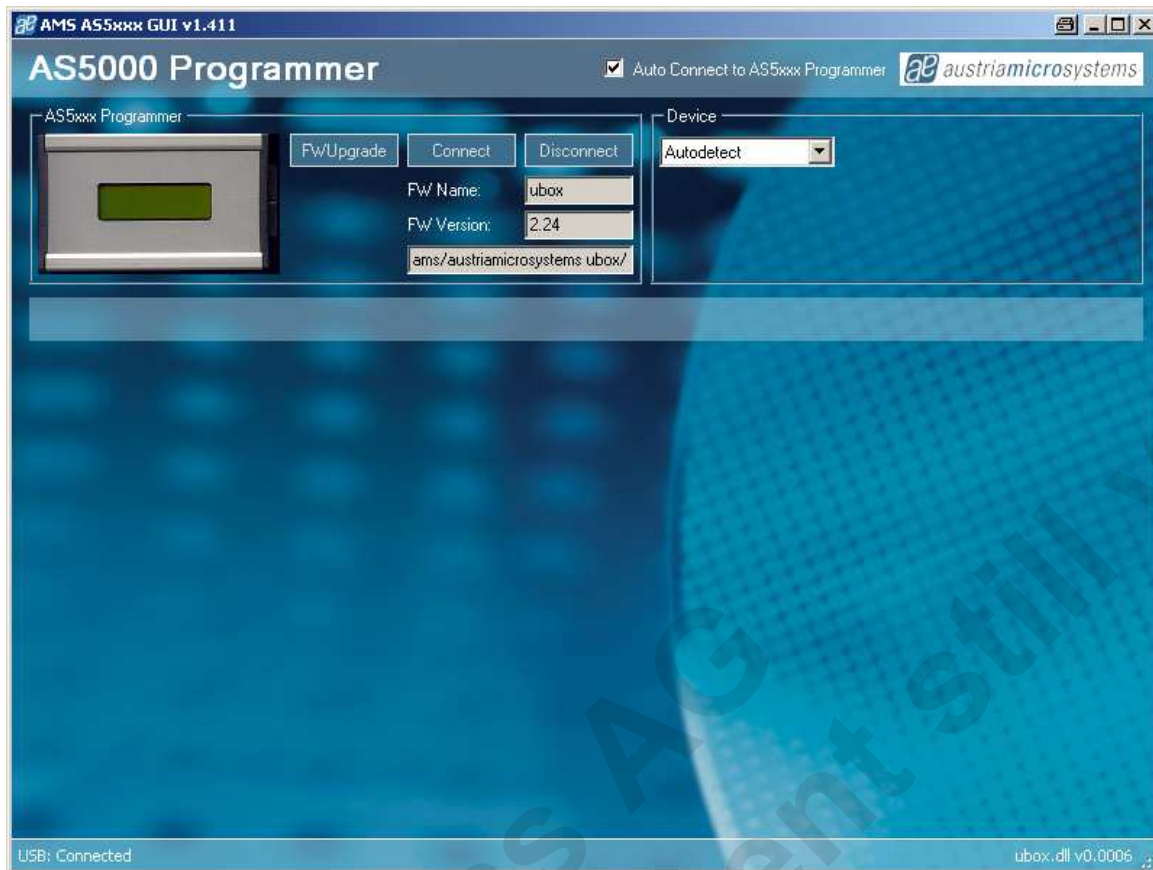

Figure 4: Main window of the GUI, no PB board inserted

Figure 4 shows the main window of the GUI.

In the top left corner, informations about the connected hardware are displayed:

- firmware (FW) type of the connected hardware: ubox (*AS5000 Programmer*) or dbrd (*Demoboard*)
- firmware (FW) version

By default the GUI is in the auto detection mode. Any austriamicrosystems device connected on the USB port (one device at the same time) will be automatically detected and displayed in the right top corner.

**Note:** The autodetect mode can be disabled and forced to any other device type by selecting the device manually.

Once a PB board inserted, tabs will be displayed allowing go into two main sections: SSI (or TWI) and OTP.

## 4.1 Programming the AS5040/AS5045/AS5140/AS5145

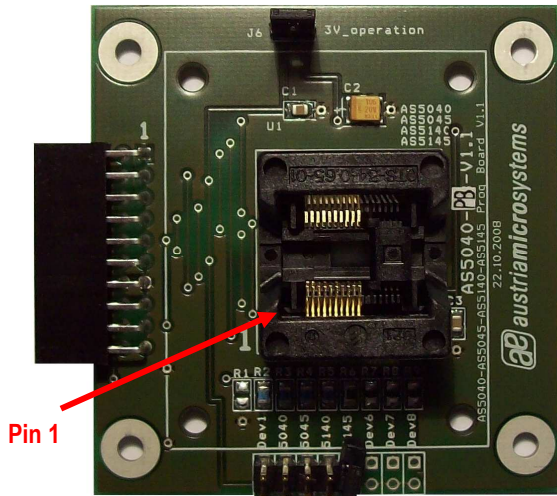

Figure 5: AS5040-PB Programming board

Programming AS5040/AS5140 encoders requires the AS5040-PB ZIF socket board. This adapter is compatible with AS5040, AS5140, AS5045 and AS5145.

Jumper J6 must be close for normal operation and programming operation.

**AS5040-PB ZIF socket board**

Device selection for autodetect:

- Jumper position 2: AS5040
- Jumper position 3: AS5045
- Jumper position 4: AS5140
- Jumper position 5: AS5145

By selecting the SSI tab, information of the angular position and the status bits appear:

Figure 6: SSI tab with AS5040 encoder inserted in AS5040-PB

- Die selection: This option is for dual die AS52xx devices only. For AS50xx and AS51xx devices Die 0 (default) must be selected.
- Value field is the raw angle extracted from the SSI stream. The angle range is 0 (0°) to 1023 (359.6°)
- Status field displays the status bits extracted from the SSI stream. Green light means that the airgap between the magnet and encoder is correct. Orange light means the magnet is too close or too far.
- CCW checkbox is the angle direction. To invert the rotating direction, check CCW.
- Zero Position field: Set button writes the actual angle value into the Zero Position register of the encoder. This programming is not permanent. The actual value will be 0 after zero position programming. To reset the zero position register, or to set a new zero position, click on Reset first.
- Read interval is the SSI stream readout and refresh rate the GUI.



Figure 7: AS5040 SSI tab after Zero Position programming

This example is the effect when the function Zero Position SET has been performed. Before programming, the encoder shows the position 651 (Figure 6). One click on Zero Position Set makes the software writing the value 651 into the OTP Zero Position register (not permanent programming). Selecting Zero Position Reset will write the value 0 to the OTP Zero Position register.

**Note:** The Zero Position function is the same for all the AS50xx, AS51xx, AS52xx rotary encoders offering this feature.

Selecting the OTP tab will read the OTP configuration from the IC.



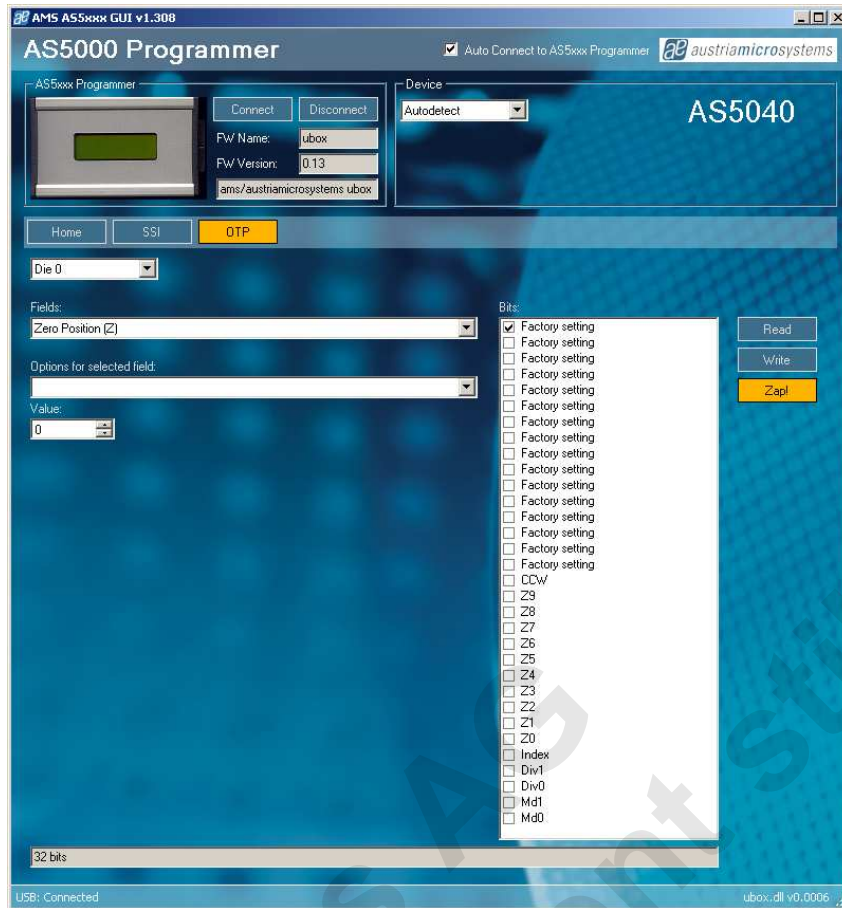

Figure 8: OTP tab of an unprogrammed AS5040

#### AS5040/AS5045:

**Read** reads the OTP configuration from the permanent fuse register.

**Write** writes the bits checked by the user into the volatile OTP register. Selecting the SSI after the configuration is possible to check the effect of the new configuration.

**Zap!** writes permanently the checked OTP bits to the encoder's fuses.

#### AS5140/AS5145:

**Load** reads the OTP configuration from the permanent fuse register.

**Read** reads the OTP configuration from the volatile register.

**Write** writes the bits checked by the user into the volatile OTP register. Selecting the SSI after the configuration is possible to check the effect.

**Zap!** writes permanently the checked OTP bits to the encoder's fuses.

## 4.2 Programming the AS5043

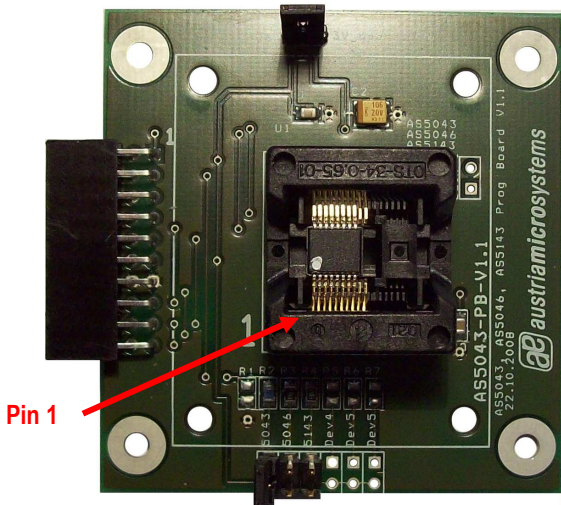

Figure 9: AS5043-PB Programming board

Programming AS5043 encoders requires the AS5043-PB ZIF socket board.

Jumper J6 must be close for normal operation and programming operation.

**AS5043-PB ZIF socket board**  
 Device selection for autodetect:  
 - Jumper position 1: AS5043

By selecting the SSI tab, information of the angular position and the status bits appear:

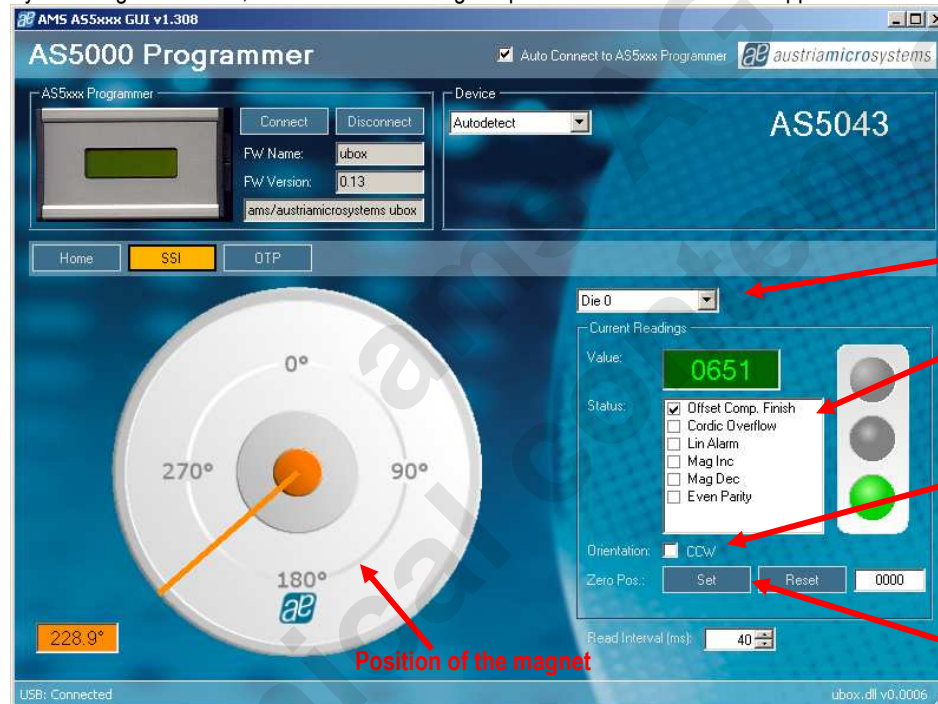

Figure 10: SSI tab with AS5043 inserted in AS5043-PB

- Die selection: This option is for dual die AS52xx devices only. For AS50xx and AS51xx devices Die 0 (default) must be selected.
- Value field is the raw angle extracted from the SSI stream. The angle range is 0 (0°) to 1023 (359.6°)
- Status field displays the status bits extracted from the SSI stream. Green light means that the airgap between the magnet and encoder is correct. Orange light means the magnet is too close or too far.
- CCW checkbox is the angle direction. To invert the rotating direction, check CCW.
- Zero Position field: Set button writes the actual angle value into the Zero Position register of the encoder. This programming is not permanent. The actual value will be 0 after zero position programming. To reset the zero position register, or to set a new zero position, click on Reset first.
- Read interval is the SSI stream readout and refresh rate the GUI.

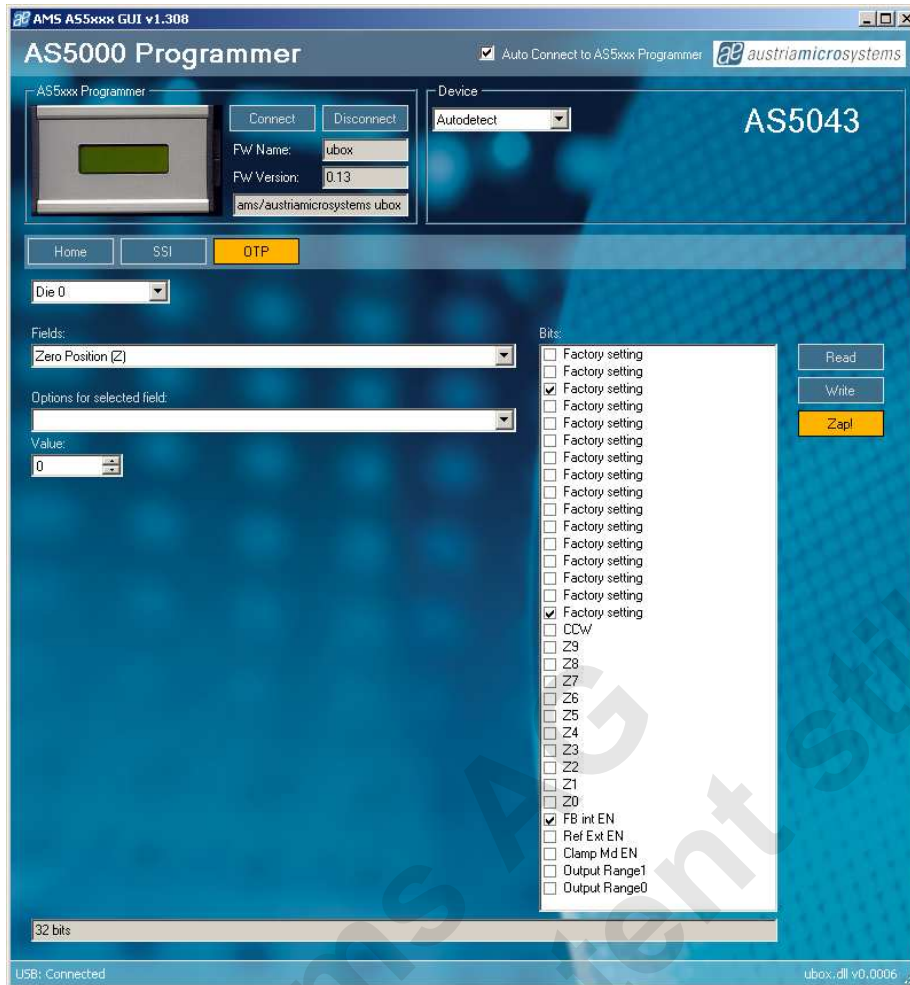

Figure 11: OTP tab of AS5043, with FBintEN option checked by user

- **AS5043:**

**Read** reads the OTP configuration from the permanent fuse register.

**Write** writes the bits checked by the user into the volatile OTP register. Selecting the SSI after the configuration is possible to check the effect of the new configuration.

**Zap!** Writes permanently the checked OTP bits to the encoder's fuses.

### 4.3 Programming the AS5245

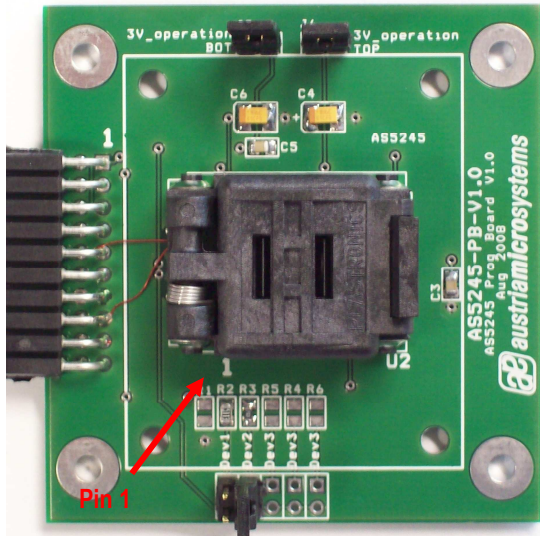

Figure 12: AS5245-PB Programming board

Programming AS5245 encoders requires the AS5245-PB socket board.

Jumper J6 (J6+J8 for AS5245) must be close for normal operation and programming operation.

**AS5245-PB ZIF socket board**  
 Device selection for autodetect:  
 - Jumper position 2: AS5245

By selecting the SSI tab, information of the angular position and the status bits appear:

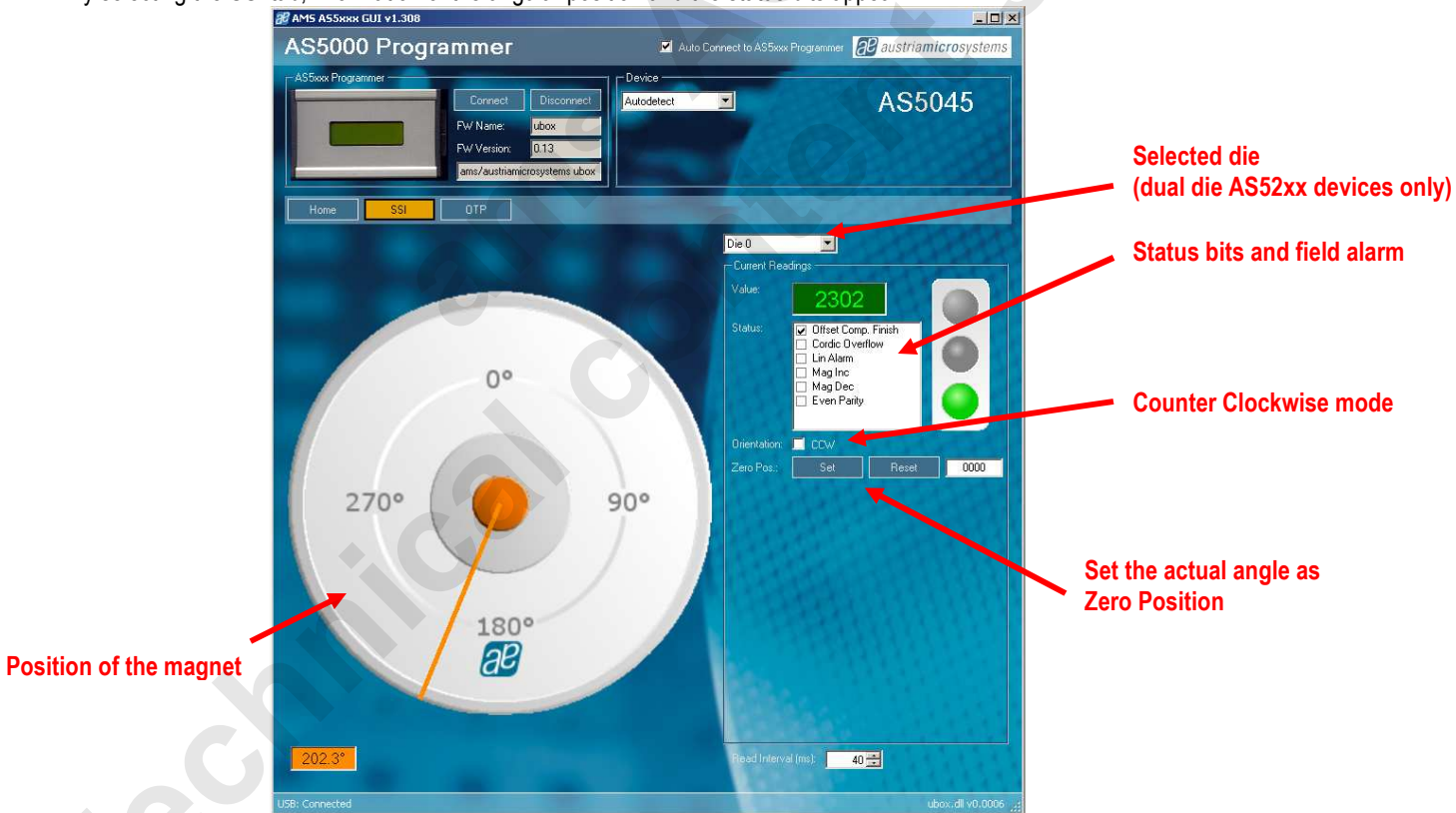

Figure 13: SSI tab with AS5045 inserted in AS5040-PB

- Die selection: This option is for dual die AS52xx devices only. For AS50xx and AS51xx devices Die 0 (default) must be selected.
- Value field is the raw angle extracted from the SSI stream. The angle range is 0 (0°) to 1023 (359.6°)
- Status field displays the status bits extracted from the SSI stream. Green light means that the airgap between the magnet and encoder is correct. Orange light means the magnet is too close or too far.
- CCW checkbox is the angle direction. To invert the rotating direction, check CCW.

- Zero Position field: Set button writes the actual angle value into the Zero Position register of the encoder. This programming is not permanent. The actual value will be 0 after zero position programming. To reset the zero position register, or to set a new zero position, click on Reset first.
- Read interval is the SSI stream readout and refresh rate the GUI.

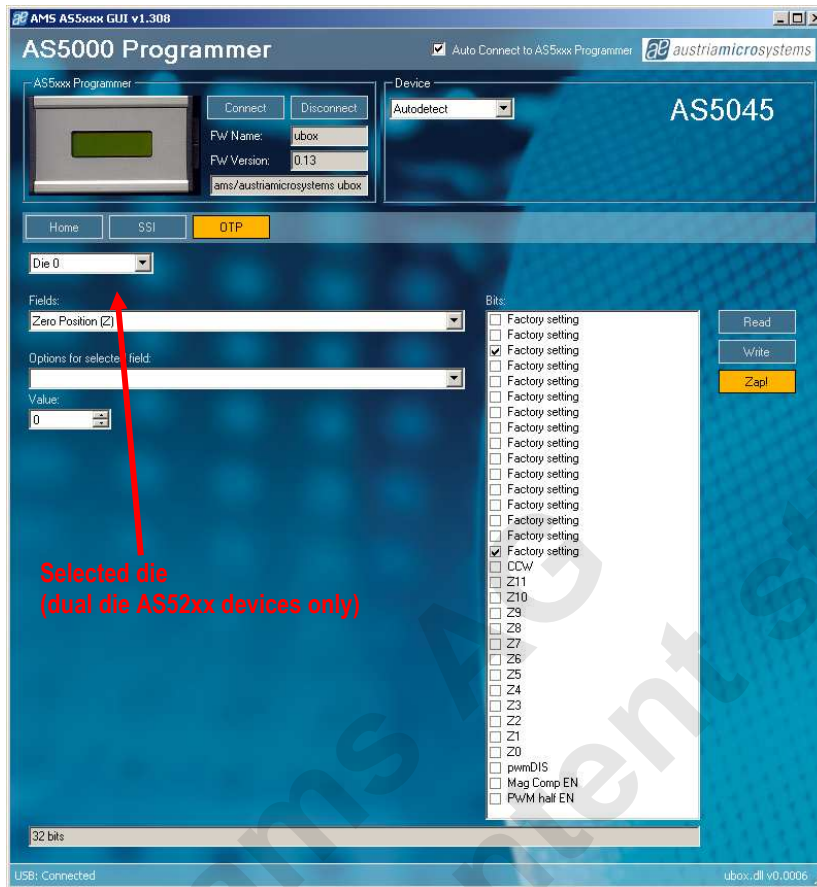

Figure 14: OTP tab of AS5045

- **AS5245:**

**Load** reads the OTP configuration from the permanent fuse register.

**Read** reads the OTP configuration from the volatile register.

**Write** writes the bits checked by the user into the volatile OTP register. Selecting the SSI after the configuration is possible to check the effect.

**Zapl** writes permanently the checked OTP bits to the encoder's fuses.

## 4.4 Programming the AS5134

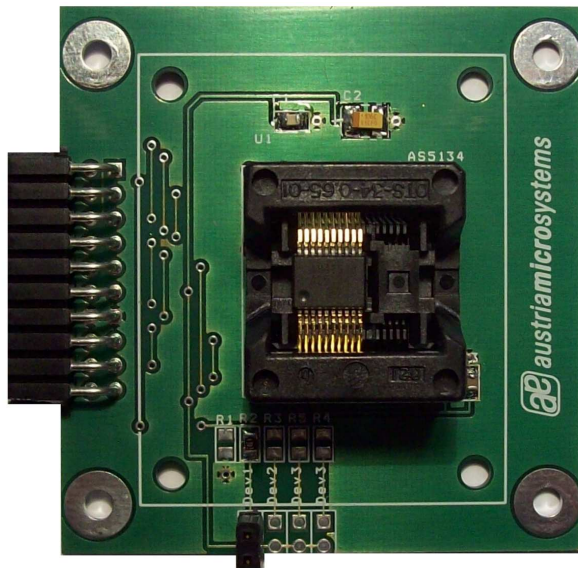

Figure 15: AS5134-PB Programming Board

Programming AS5134 encoders requires the AS5134-PB socket board.

### AS5134-PB ZIF socket board

Device selection:

- Jumper position 1: AS5134

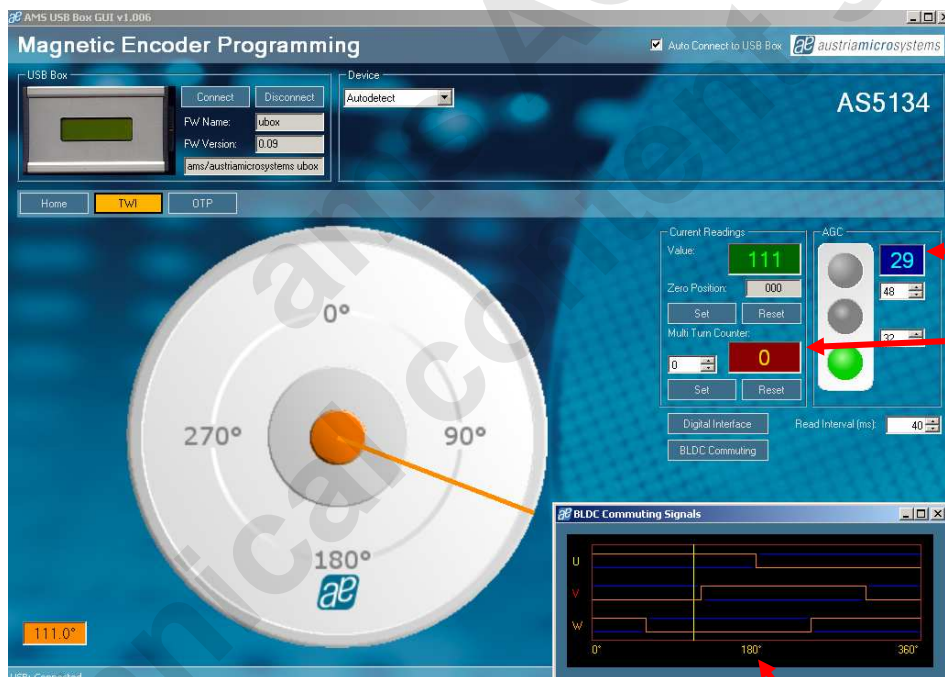

Figure 16: GUI for the AS5134

Additional window for the BLDC output signals

- Value field is the raw angle extracted from the interface. The angle range is 0° to 359°
- Status field (AGC) displays the status bits depending on the set AGC values. Green light means that the airgap between the magnet and encoder is correct. Red light means the magnet is too far away.
- Zero Position field: Set button writes the actual angle value into the Zero Position register of the encoder. This programming is not permanent. The actual value will be 0 after zero position programming. To reset the zero position register, or to set a new zero position, click on Reset first.
- Read interval is the readout and refresh rate the GUI.
- Digital interface opens an additional window (see Figure 17), which provides all communications commands like WRTIE\_CONFIG or EN\_PROG (for entering the extended mode).

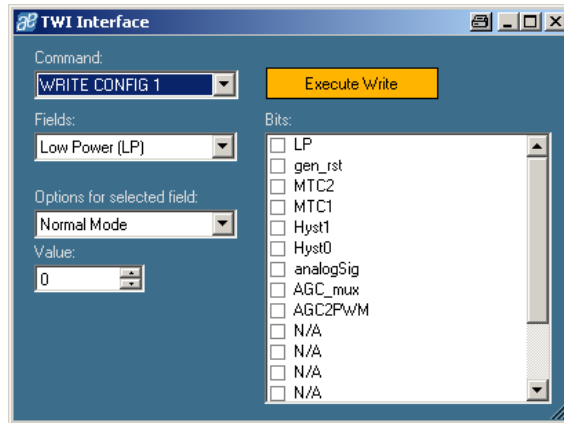

Figure 17: Communication command window

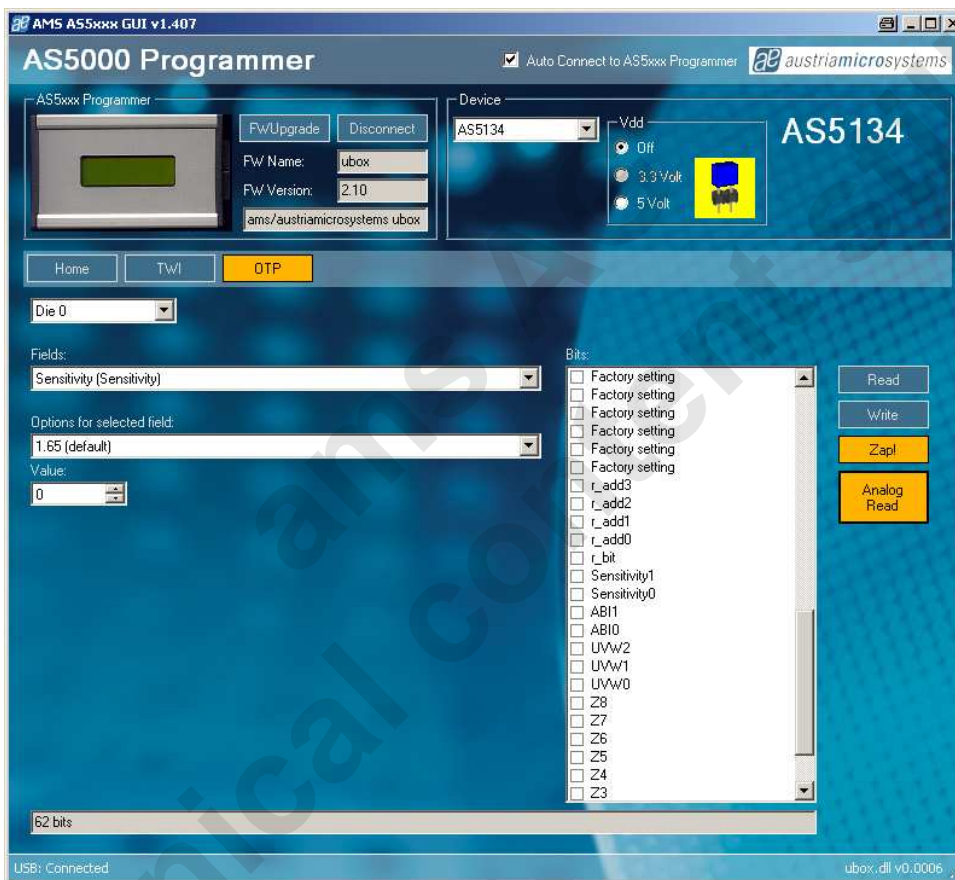

Figure 18: OTP tab of AS5134

- **AS5134:**

**Read** reads the OTP configuration from the permanent fuse register.

**Write** writes the bits checked by the user into the volatile OTP register. Selecting the SSI after the configuration is possible to check the effect of the new configuration.

**Zap!** writes permanently the checked OTP bits to the encoder's fuses.

**Analog Readback** is not implemented yet. It will be available soon.

### 4.5 Programming the AS5163/AS5263

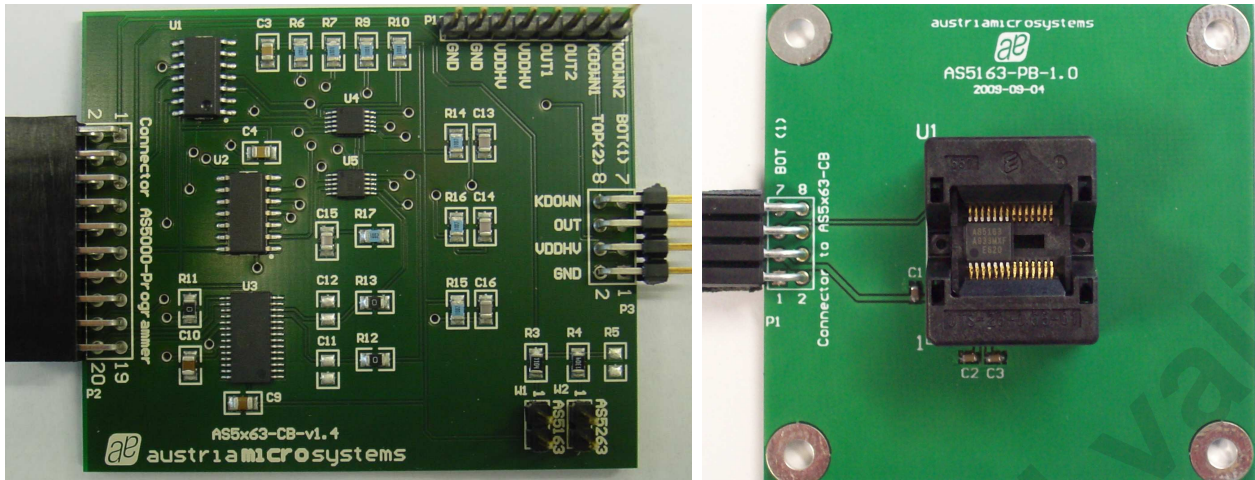

Figure 19: AS5x63-CB Connection Board (left) and AS5163-PB Programming Board (right)

Programming AS5163/AS5263 encoders requires the AS5163-PB/AS5263-PB socket board and the AS5x63-CB connection board.

The connection board provides the load, needed for programming and operating the AS5163/AS5263.

Further details concerning all programming options are provided in **application note AN5163-10** (available on our webpage).

### 4.6 Programming the AS5115/AS5215

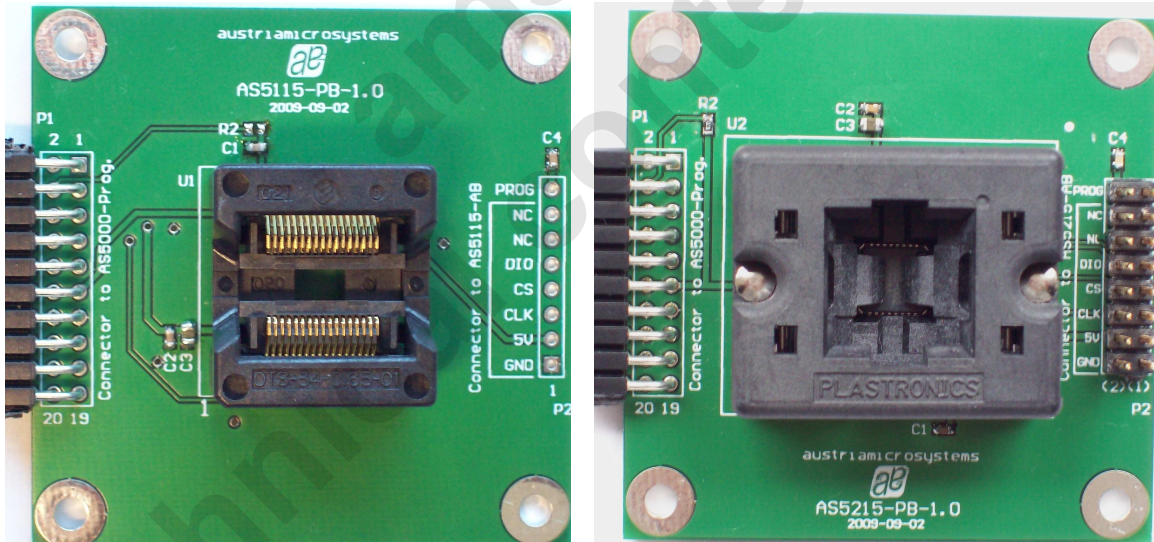

Figure 20: AS5115-PB Programming Board (left) and AS5215-PB Programming Board (right)



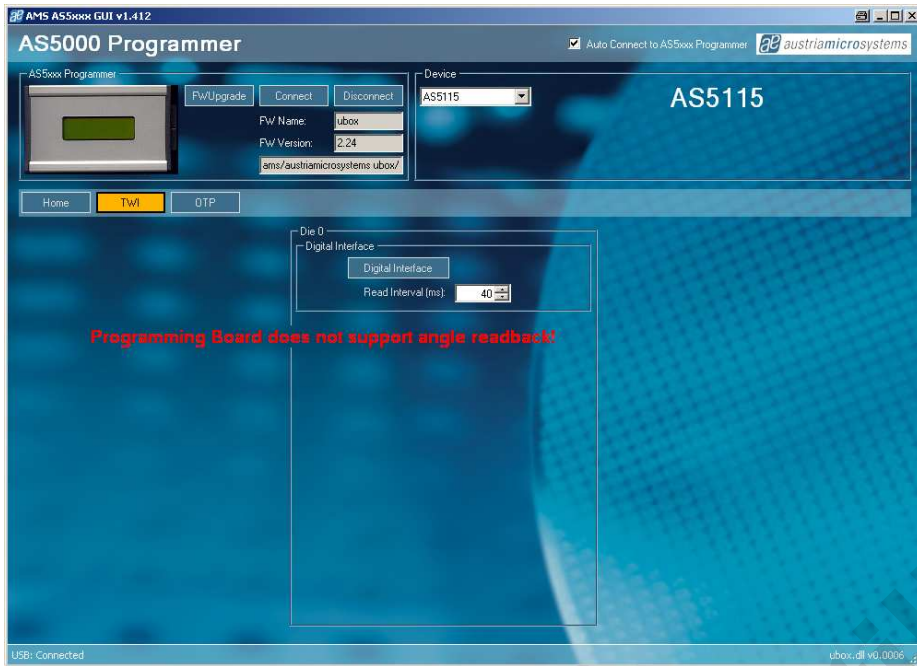

Figure 21: TWI tab of AS5115

The AS5115-PB and AS5215-PB does not support an angle readback of the analogue outputs.

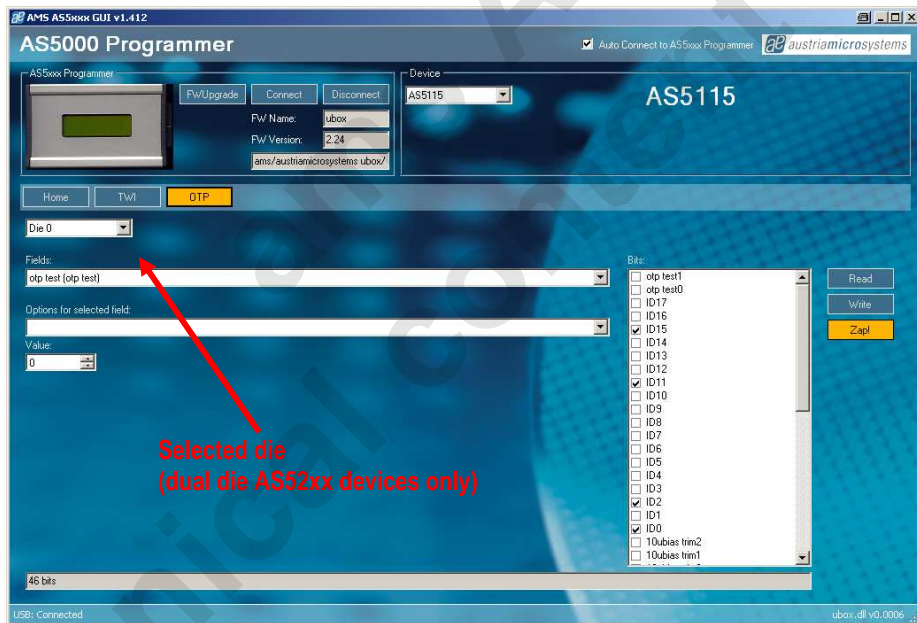

Figure 22: OTP tab of AS5115

- **AS5115/AS5215:**

**Read** reads the OTP configuration from the permanent fuse register.

**Write** writes the bits checked by the user into the volatile OTP register. Selecting the SSI after the configuration is possible to check the effect of the new configuration.

**Zap!** writes permanently the checked OTP bits to the encoder's fuses.

## 5 Programming boards (PB) Schematics

### 5.1 AS5040-PB-1.1

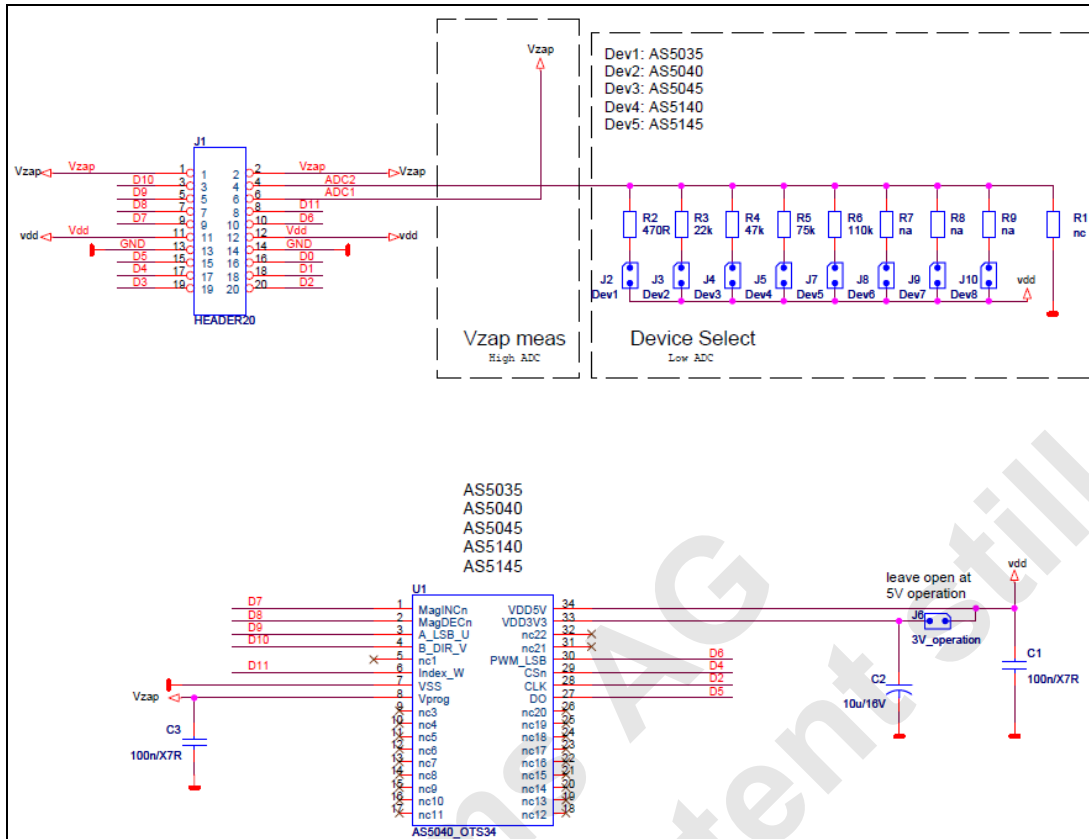

### 5.2 AS5043-PB-1.1

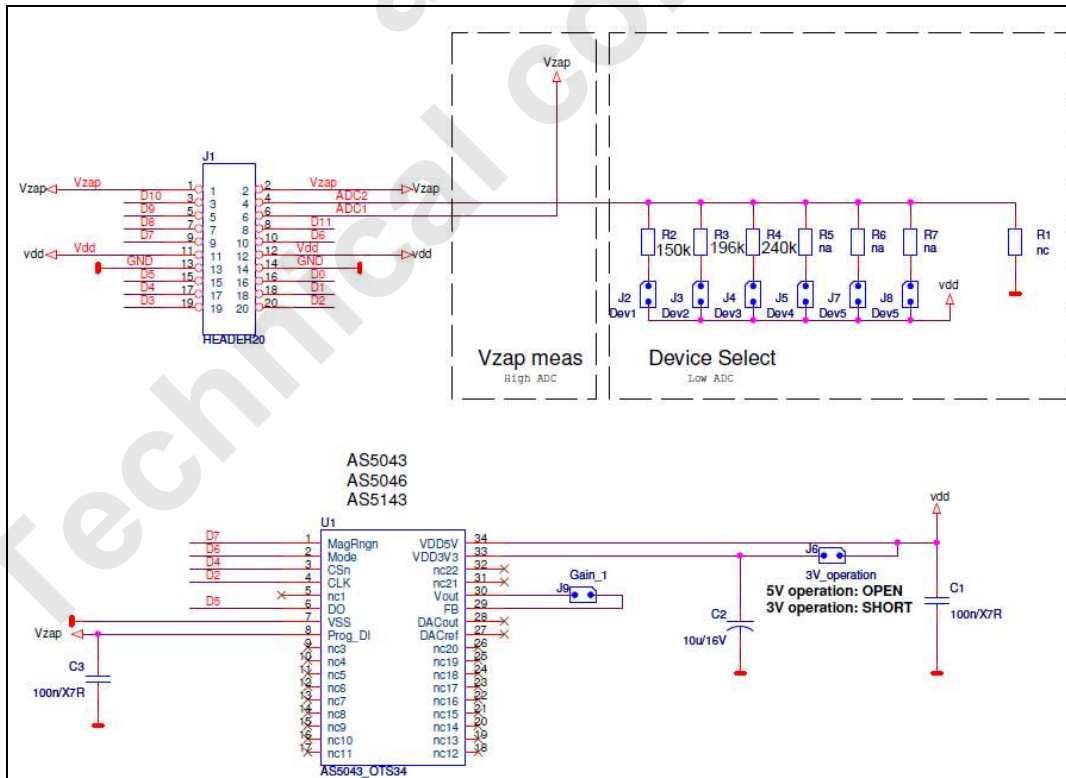

### 5.3 AS5115-PB1.1

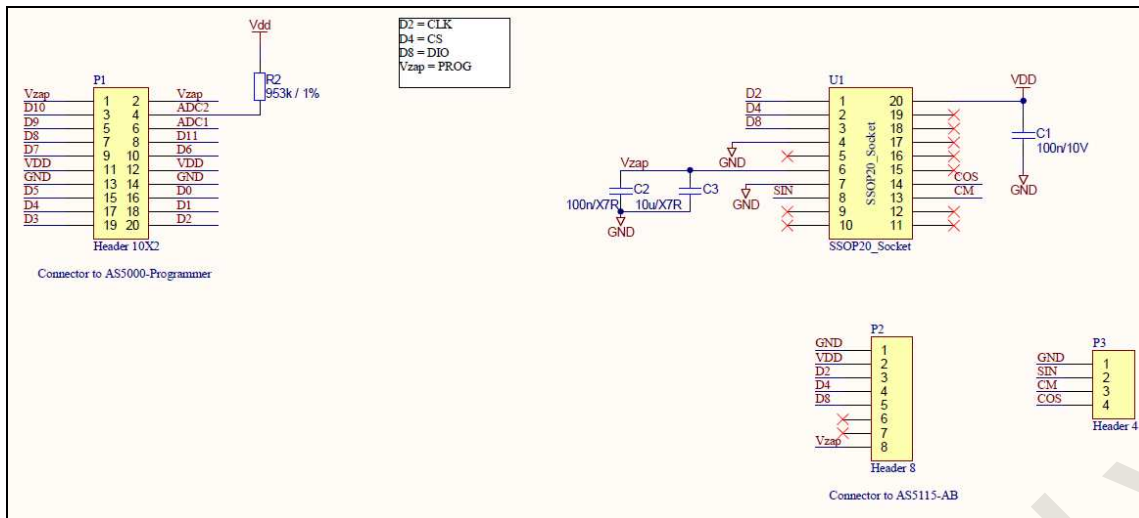

### 5.4 AS5134-PB-1.1

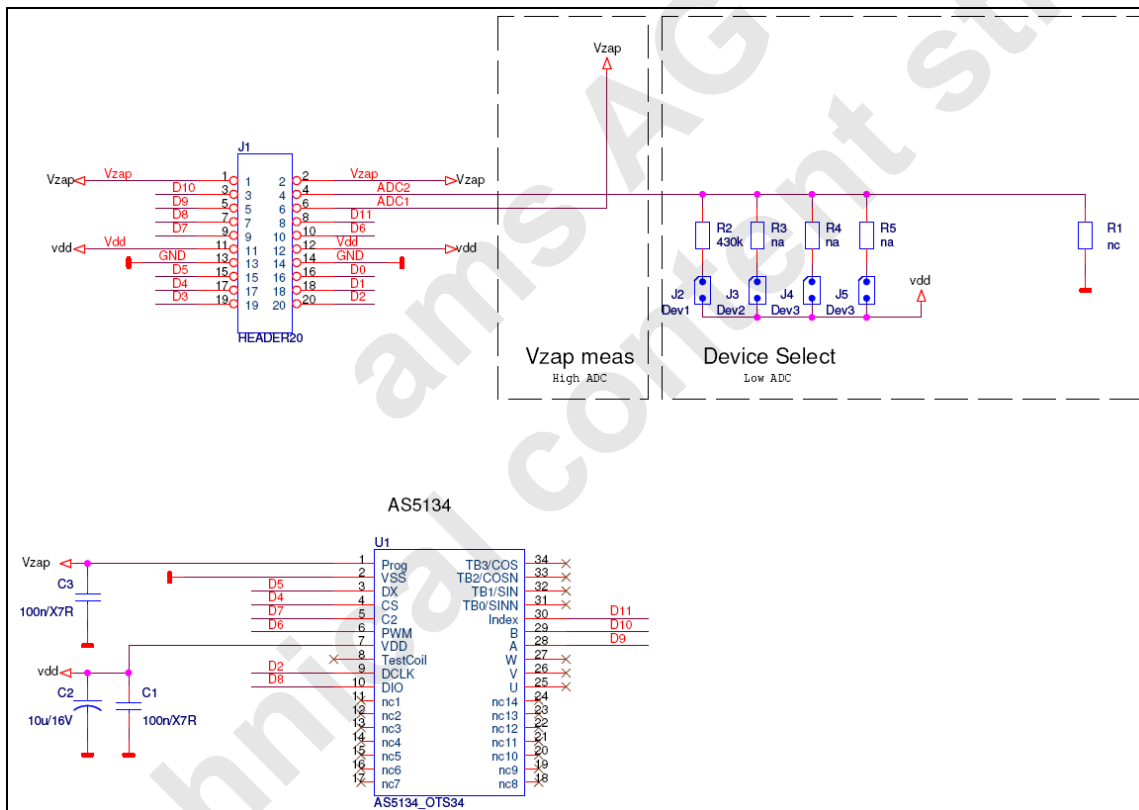

### 5.5 AS5163-PB-1.0

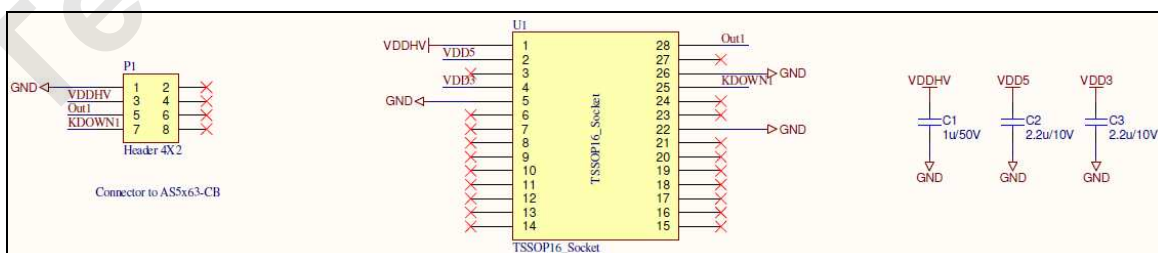



## Appendix A

Programming Board Part number	AS5030 PB	AS5040 PB	AS5043 PB	AS5115 PB	AS5130 PB	AS5134 PB	AS5163 PB	AS5215 PB	AS5245 PB	AS5263 PB	Supported by firmware ≥
AS5030	•										Future Release
AS5040		•									0.12
AS5043			•								0.12
AS5045		•									0.12
AS5046			•								Future Release
AS5115				•							2.24
AS5130					•						Future Release
AS5134						•					0.10
AS5140		•									0.10
AS5145		•									0.10
AS5163							•				0.13
AS5215								•			2.24
AS5245									•		0.10
AS5263										•	0.13

Index	
1	General Overview ..... 1
2	Hardware Components ..... 1
2.1	Description of the Hardware Components ..... 1
2.2	Description of the programming board ..... 3
3	Installation ..... 4
3.1	Hardware setup ..... 4
3.2	Installing the GUI on the PC ..... 4
4	Graphical User Interface (GUI) ..... 5
4.1	Programming the AS5040/AS5045/AS5140/AS5145 ..... 6
4.2	Programming the AS5043 ..... 9
4.3	Programming the AS5245 ..... 11
4.4	Programming the AS5134 ..... 13
4.5	Programming the AS5163/AS5263 ..... 15
4.6	Programming the AS5115/AS5215 ..... 15
5	Programming boards (PB) Schematics ..... 17
5.1	AS5040-PB-1.1 ..... 17
5.2	AS5043-PB-1.1 ..... 17
5.3	AS5115-PB1.1 ..... 18
5.4	AS5134-PB-1.1 ..... 18
5.5	AS5163-PB-1.0 ..... 18
5.6	AS5215-PB-1.1 ..... 19
5.7	AS5245-PB-1.1 ..... 19
5.8	AS5263-PB-1.0 ..... 19
Appendix A ..... 20	
Revision History ..... 22	
Contact ..... 23	
Sales Offices ..... 23	
Copyright ..... 24	

## Revision History

Revision	Date	Description
R1.0	March.29, 2008	New copy
R1.1	May 22, 2008	All paragraphs, new pictures included
R1.2	June 16, 2008	AS5134 device added
R1.3	September 4, 2008	New devices added, minor corrections
R1.4	September 26, 2008	Minor corrections
R1.5	December 15, 2008	Minor corrections
R1.6	January 26, 2009	Layout modification, PB schematics
R1.7	March 3, 2009	Supported devices table added
R1.8	August 10, 2009	AS5x40, AS5x45 chapter added, screenshot updated.
R1.9	February 04, 2010	AS5134 updated, AS5143 removed, AS5245 added
R1.10	March 04, 2010	AS5115, AS5215, AS5163 and AS5263 added

## Contact

### Headquarters

austriamicrosystems AG  
 A 8141 Schloss Premstätten, **Austria**  
 Phone: +43 3136 500 0  
 Fax: +43 3136 525 01  
[industry.medical@austriamicrosystems.com](mailto:industry.medical@austriamicrosystems.com)  
[www.austriamicrosystems.com](http://www.austriamicrosystems.com)

### Sales Offices

austriamicrosystems Germany GmbH  
 Tegemseer Landstrasse 85  
 D-81539 München, **Germany**  
 Phone: +49 89 69 36 43 0  
 Fax: +49 89 69 36 43 66

austriamicrosystems Italy S.r.l.  
 Via A. Volta, 18  
 I-20094 Corsico (MI), **Italy**  
 Phone: +39 02 4586 4364  
 Fax: +39 02 4585 773

austriamicrosystems France S.A.R.L.  
 124, Avenue de Paris  
 F-94300 Vincennes, **France**  
 Phone: +33 1 43 74 00 90  
 Fax: +33 1 43 74 20 98

austriamicrosystems Switzerland AG  
 Rietstrasse 4  
 CH 8640 Rapperswil, **Switzerland**  
 Phone: +41 55 220 9008  
 Fax: +41 55 220 9001

austriamicrosystems UK, Ltd.  
 88, Barkham Ride,  
 Finchampstead, Wokingham  
 Berkshire RG40 4ET, **United Kingdom**  
 Phone: +44 118 973 1797  
 Fax: +44 118 973 5117

austriamicrosystems AG  
 Klaavuntie 9 G 55  
 FI 00910 Helsinki, **Finland**  
 Phone: +358 9 72688 170  
 Fax: +358 9 72688 171

austriamicrosystems AG  
 Bivågen 3B  
 S 19163 Sollentuna, **Sweden**  
 Phone: +46 8 6231 710

austriamicrosystems USA, Inc.  
 8601 Six Forks Road  
 Suite 400  
 Raleigh, NC 27615, **USA**  
 Phone: +1 919 676 5292  
 Fax: +1 509 696 2713

austriamicrosystems USA, Inc.  
 4030 Moorpark Ave  
 Suite 116  
 San Jose, CA 95117, **USA**  
 Phone: +1 408 345 1790  
 Fax: +1 509 696 2713

austriamicrosystems AG  
 Suite 811, Tsimshatsui Centre  
 East Wing, 66 Mody Road  
 Tsim Sha Tsui East, Kowloon, **Hong Kong**  
 Phone: +852 2268 6899  
 Fax: +852 2268 6799

austriamicrosystems AG  
 AIOS Gotanda Annex 5<sup>th</sup> Fl., 1-7-11,  
 Higashi-Gotanda, Shinagawa-ku  
 Tokyo 141-0022, **Japan**  
 Phone: +81 3 5792 4975  
 Fax: +81 3 5792 4976

austriamicrosystems AG  
 #805, Dong Kyung Bldg.,  
 824-19, Yeok Sam Dong,  
 Kang Nam Gu, Seoul  
**Korea** 135-080  
 Phone: +82 2 557 8776  
 Fax: +82 2 569 9823

austriamicrosystems AG  
 Singapore Representative Office  
 83 Clemenceau Avenue, #02-01 UE Square  
 239920, **Singapore**  
 Phone: +65 68 30 83 05  
 Fax: +65 62 34 31 20